

2X TAB FOR A & A1
AND B & B1

FOCU
BY DC
OCT 2

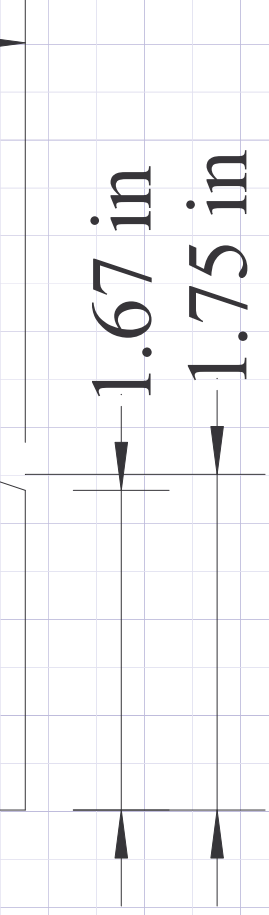

(2X) TAB FOR D AND F

SER LIGHT SHIELD ON PECKHAM 007

4X 0.75 in

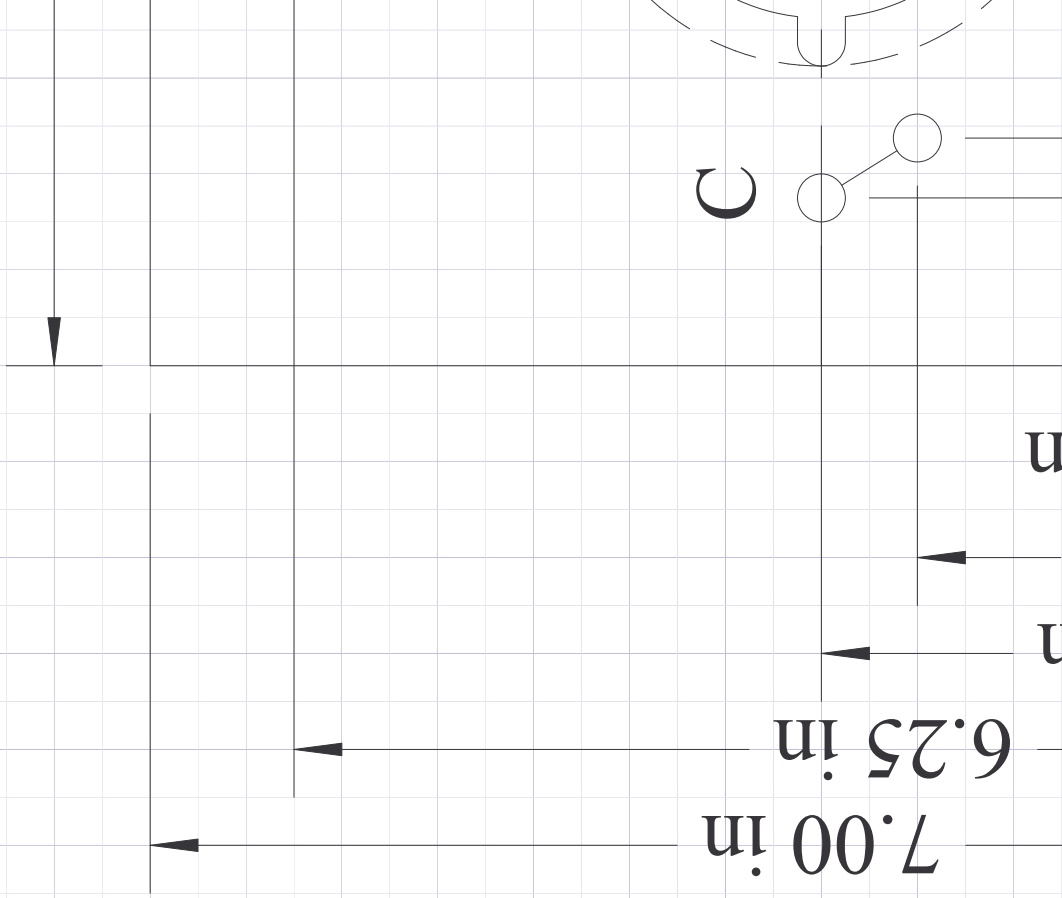

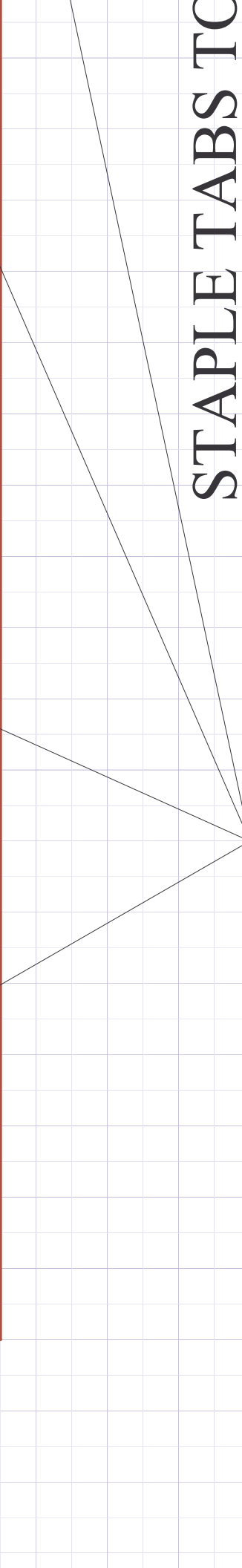

STAPLE TABS TO
SLOT WITH THE

8.50 in

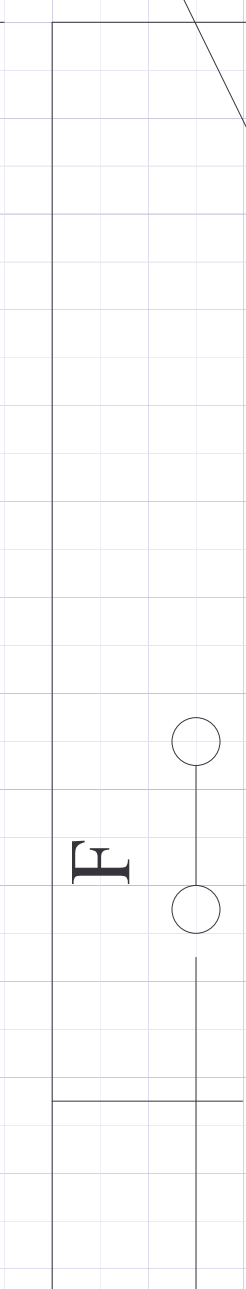

CHOOSE A DIAMETER
OF Y
A SNUG FIT WITH

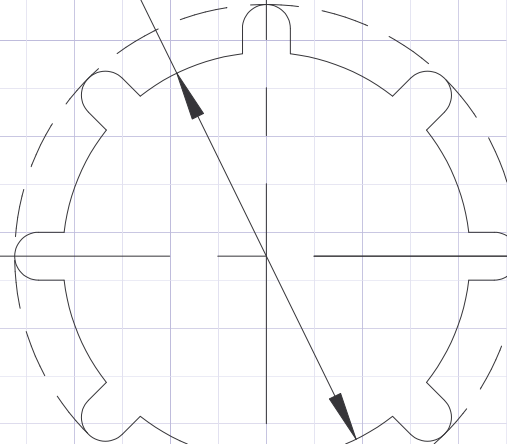

F

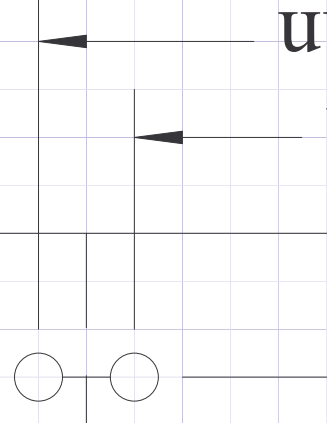

F

OD FIT RECTANGULAR MOUNTING PIECE
SAME LETTER.

R0.13 in

1.

METER THAT RESULTS IN
H THE OUTSIDE DIAMETER
OUR FOCUSER.

2x R0.13

R1.25



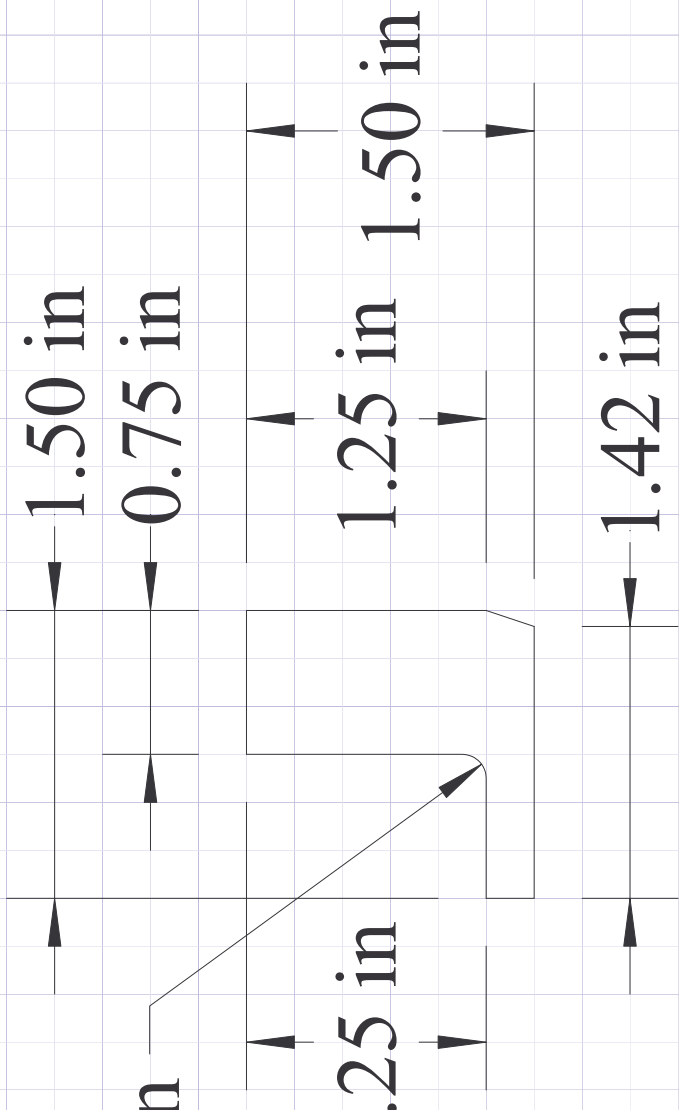

(2X) TAB FOR C AND E

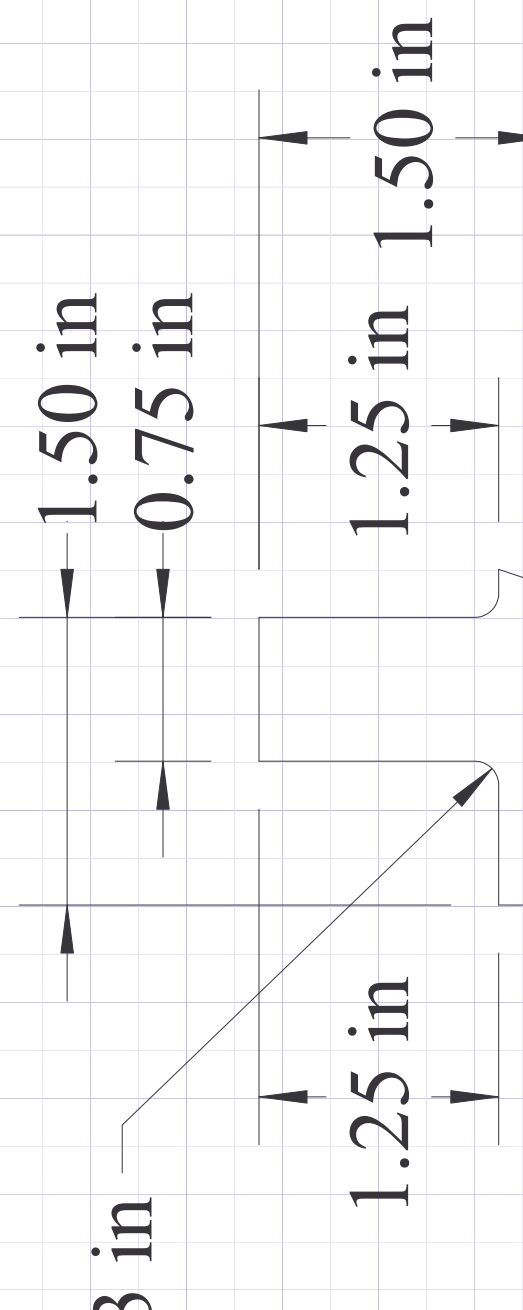

B

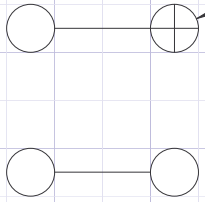

16X

Ø0.25 in

STAPLE BLACK CLOTH

0.75 in

n

C

D

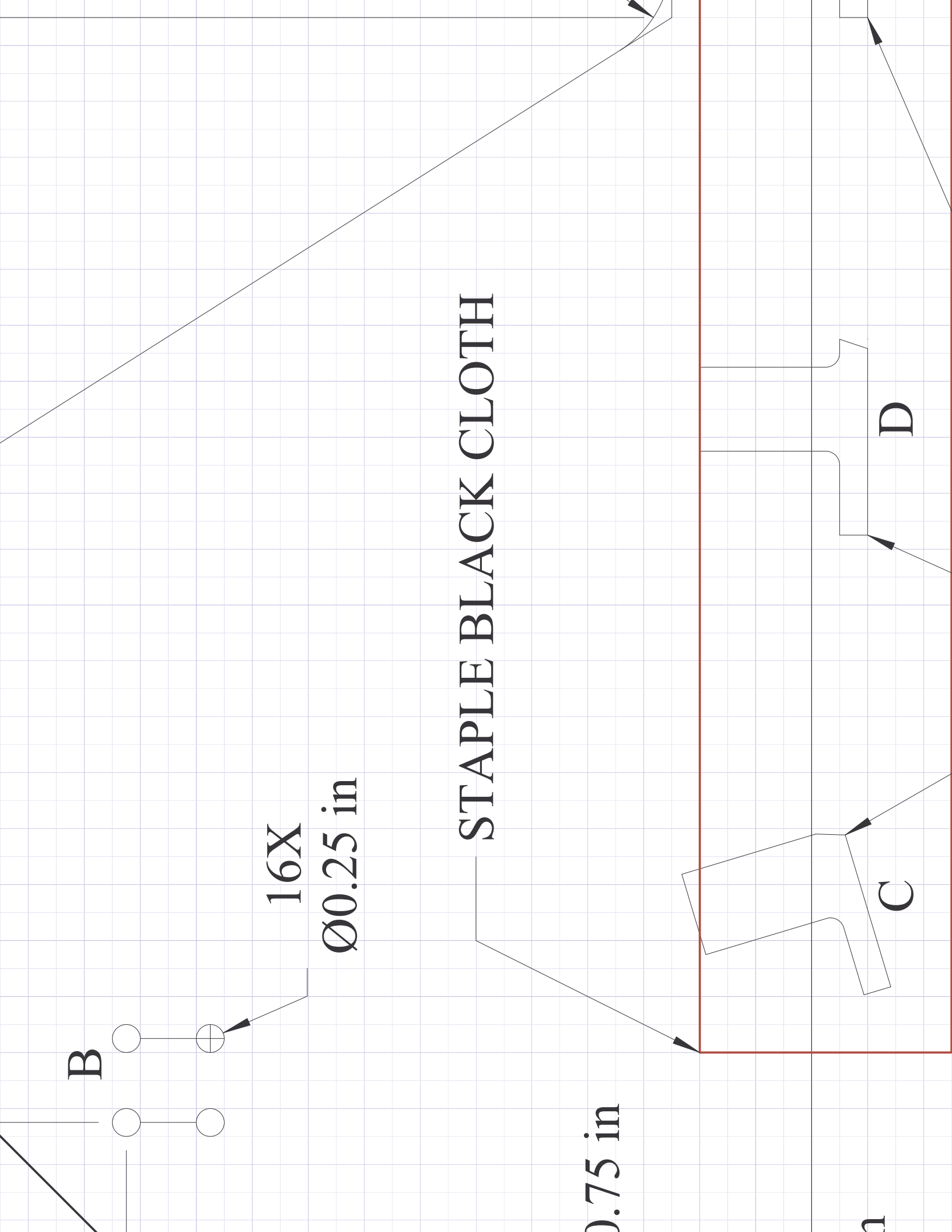

R1.00 in

LINE UP PATTERNS A &
INSERT A-B TAB.

1.25 in

E

F

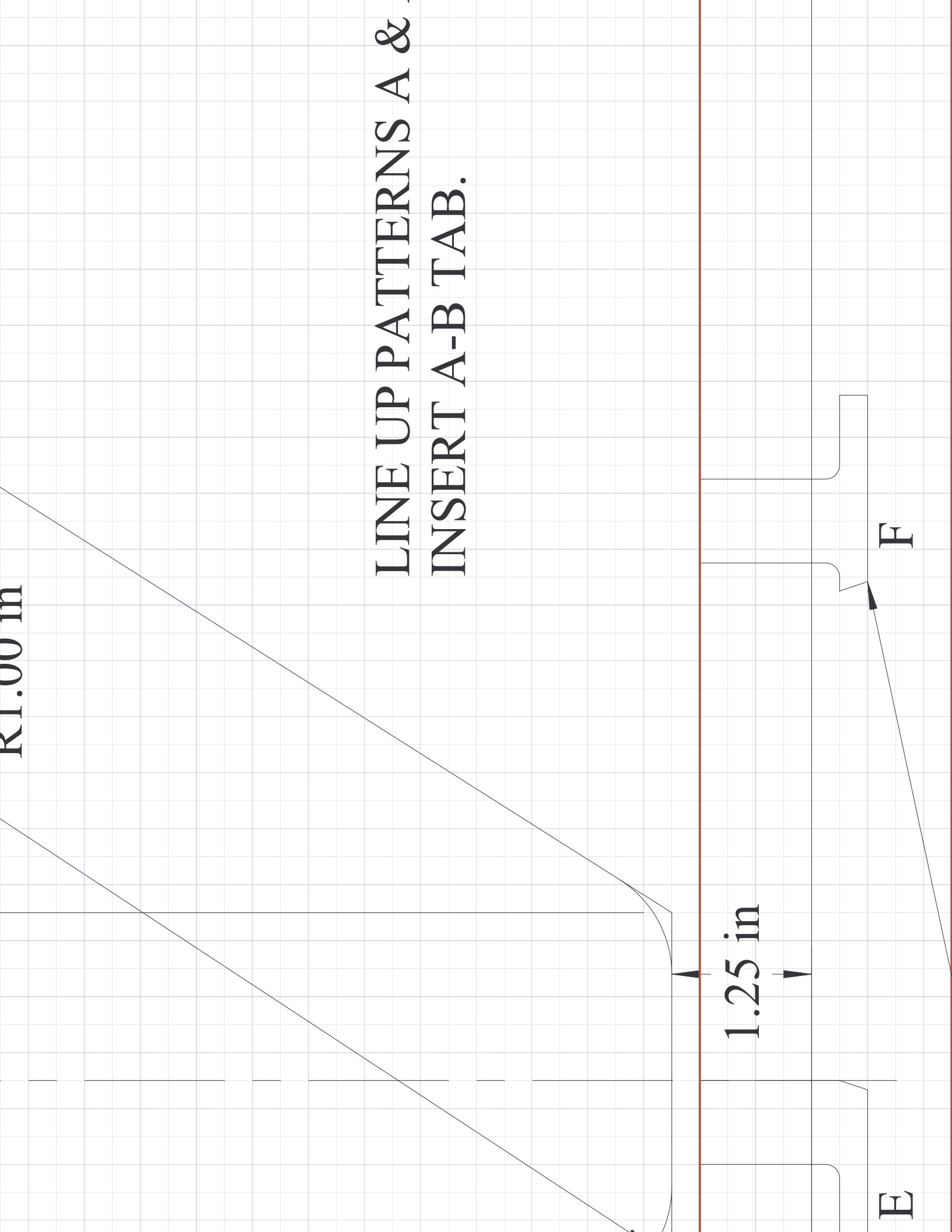

A1

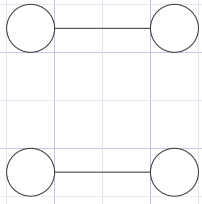

A1, AND B & B1.

B1

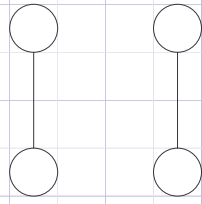



6.75 in

2X

4.75 in



26.75 in

23.00 in

18.25 in

15.25 in

10.50 in

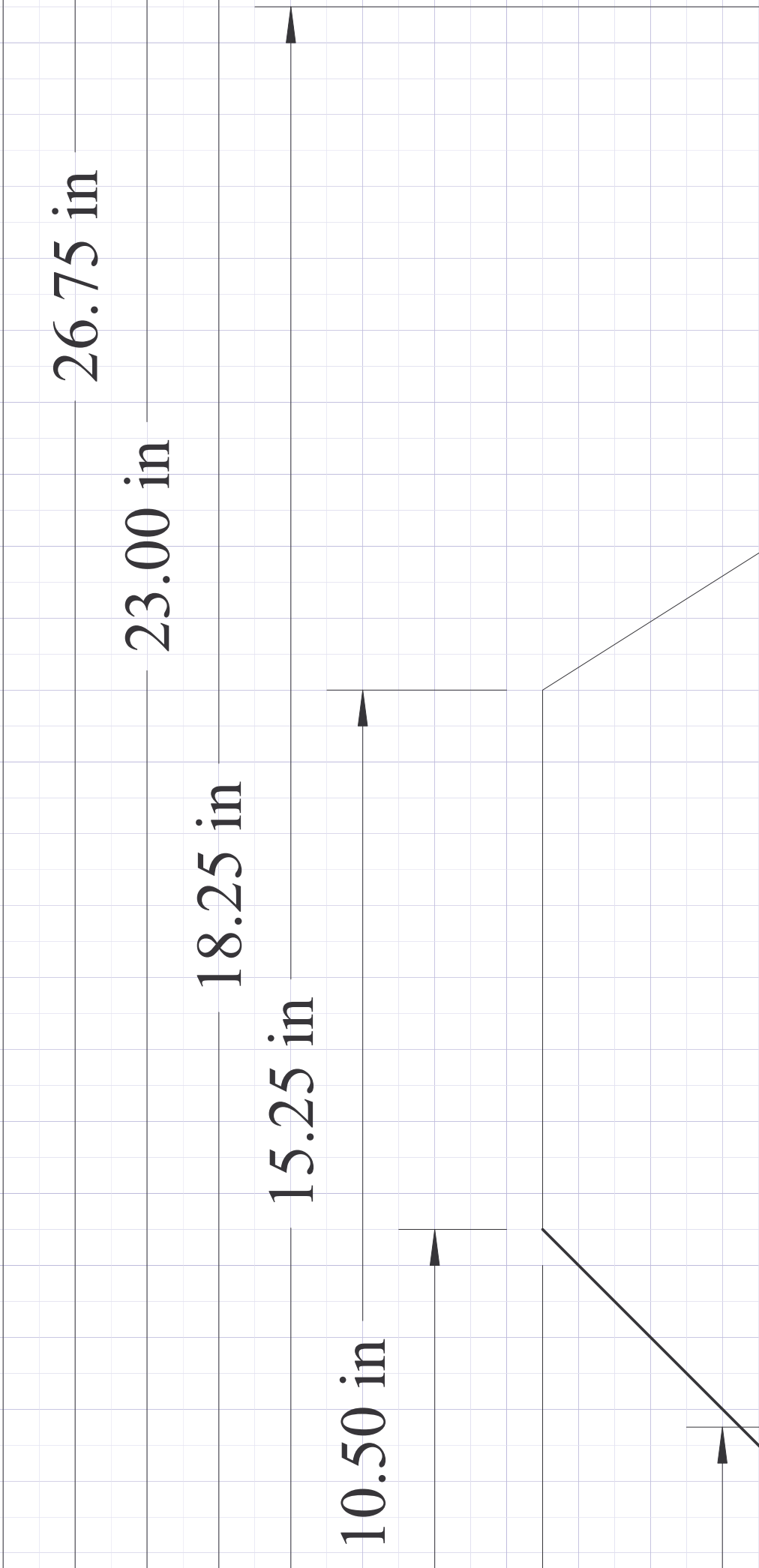

33.50 in



2X

D1.00 in

